





# 1-800-BOLLARDS

**The Bollard Experts**

- 4" BOLLARD COVER  
(3" NOMINAL BOLLARD SIZE)
- CSS4010 SCHED 10 STAINLESS STEEL COVER
- STAINLESS STEEL BOLLARD COVER FINISH
- POLISHED #4
- SELECT DESIRED STAINLESS STEEL BOLLARD MATERIAL:
- TYPE 304
- TYPE 316
- SELECT DESIRED BOLLARD CAP STYLE:
-  DOME (SHOWN)
-  STANDARD FLAT
-  REVEAL
-  SLOPED
- COVER HEIGHT SELECTION FROM:
- BASE OF BOLLARD
- TOP OF BOLLARD \_\_\_\_\_ INCHES

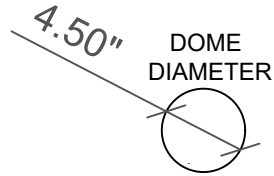

4.50" OD

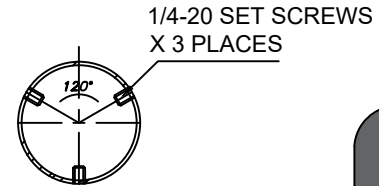

3" NOMINAL

36.00"

1/4-20 SET SCREWS X 3 PLACES

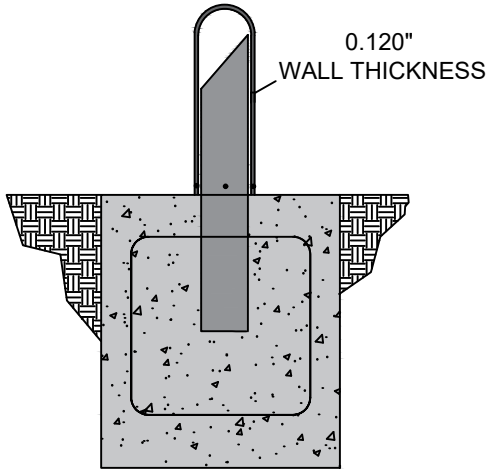

REVISIONS			
LTR	DESCRIPTION	DATE	APPVD

COMMENTS

SPECIFICATIONS  
HEIGHT: 36"  
DIAMETER: 4.50"  
WALL THICKNESS: 0.120"

DOME (SHOWN) STANDARD FLAT REVEAL SLOPED

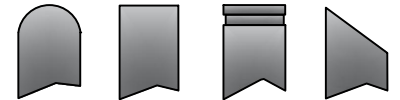

NOTES:  
1. INSTALLATION TO BE COMPLETED IN ACCORDANCE WITH MANUFACTURER'S SPECIFICATIONS.  
2. DO NOT SCALE DRAWING.  
3. THIS DRAWING IS INTENDED FOR USE BY ARCHITECTS, ENGINEERS, CONTRACTORS, CONSULTANTS AND DESIGN PROFESSIONALS FOR PLANNING PURPOSES ONLY. THIS DRAWING MAY NOT BE USED FOR CONSTRUCTION.  
4. ALL INFORMATION CONTAINED HEREIN WAS CURRENT AT THE TIME OF DEVELOPMENT BUT MUST BE REVIEWED AND APPROVED BY THE PRODUCT MANUFACTURER TO BE CONSIDERED ACCURATE.  
5. CONTRACTOR'S NOTE: FOR PRODUCT AND COMPANY INFORMATION VISIT [www.CAD9000.com/info](http://www.CAD9000.com/info) AND ENTER REFERENCE NUMBER 5046-027.

APPLICATION	
NEXT ASSY	USED ON

SERIES NUMBER: <b>XX-S060-XX</b>	CAGE CODE: <b>6NGJB</b>	REV: <b> </b>	DRAWING NUMBER: <b>6th Cutsheet Size A - R1</b>
PRODUCT FAMILY: <b>FIXED BOLLARD</b>	DRAWN BY: <b>AJA</b>	DRAWING REV: <b> </b>	
PRODUCT CLASS: <b>STANDARD OR CUSTOMER DEFINED</b>	CHECKED BY: <b> </b>	SHEET: <b>1 OF 1</b>	
PRODUCT LINE: <b>BOLLARD</b>	APPROVED BY: <b> </b>	RELEASE DATE: <b> </b>	
PRODUCT SUB LINE: <b>COVER</b>	TITLE: <b>BOLLARD, COVER</b>		
<b>1-800-BOLLARDS, Inc.</b> 10 Hughes Suite A105 Irvine, CA 92618 PHONE: 1-800-BOLLARDS WEB: <a href="http://www.1800BOLLARDS.COM">www.1800BOLLARDS.COM</a> EMAIL: <a href="mailto:info@1800BOLLARDS.COM">info@1800BOLLARDS.COM</a>			